

MC 2D

PERFORATRICE IDRAULICA CINGOLATA
HYDRAULIC CRAWLER DRILL

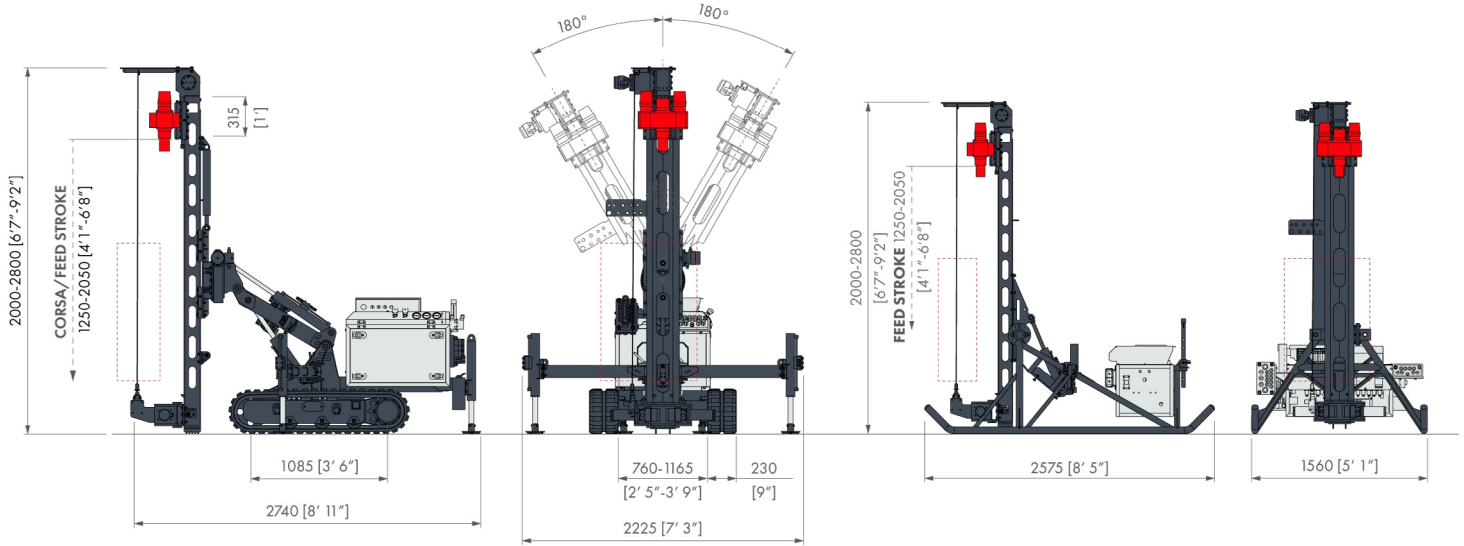

ALLESTIMENTO STANDARD STANDARD SET-UP



RUOTE WHEEL

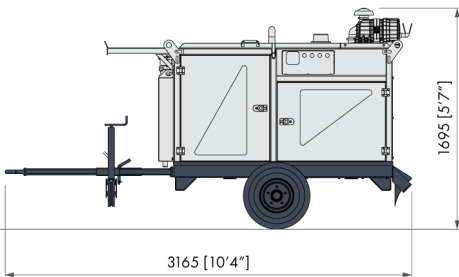

CINGOLO CRAWEL

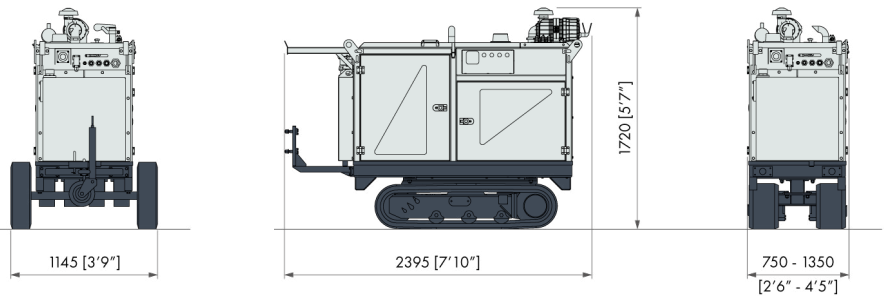

TESTA SINGOLA - SINGLE HEAD



Rotazione
Rotary Drilling



Rotopercussione
Rotary-Percussive

	m.s.	i.s.	DIESEL		ELECTRIC	
Motore Engine						
Potenza Motore Engine Power	kW	HP	33	44	30	40
Livello Emissioni Emission Level	-	-	Stage 3A/Tier 3 - Stage 5/Tier 4 final			-
Corsa Mast Mast Feed Stroke	mm	ft-in	1.250 - 2.050	4' 1" - 6' 8"		
Forza di Spinta Feed Force	daN	lbs	1.200	2,697		
Forza di Tiro Retract Force	daN	lbs	1.200	2,697		
Coppia Rotary Rotary Torque Range	daNm	lb*ft	200 - 430	1,475 - 3,171		
Giri Rotary Rotary Speed Range	rpm		80 - 810			
Serraggio Morse Clamp Range	mm	in	45 - 185	1" 3/4 - 7" 5/16		
Peso Perforatrice Rig Weight	ton		0,6 - 1,5			
Peso Centrale Power Pack Weight	ton		1 - 2,2			

OPZIONI E ACCESSORI

OPTIONS AND ACCESSORIES

<p>Centrale cingolata <i>Power pack on crawl</i></p>	<p>Centratore guida aste <i>Rod guiding device</i></p>
<p>Centrale su carrello gommato <i>Power pack on a wheel frame</i></p>	<p>Radiocomando <i>Remote radio control</i></p>
<p>Morsa doppia <i>Double clamps</i></p>	<p>Kit CE <i>CE Marking kit</i></p>
<p>Martello idraulico <i>Hydraulic drifter</i></p>	<p>Sistema ComNect <i>ComNect System</i></p> 
<p>Argano idraulico <i>Hydraulic winch</i></p>	

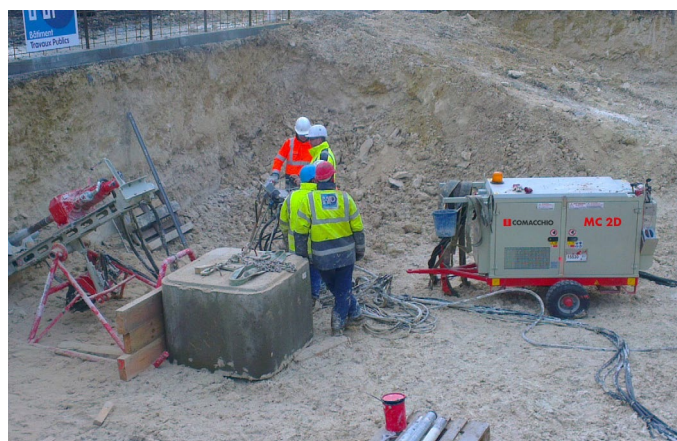

MOVIMENTAZIONE MAST MAST MOVEMENTS

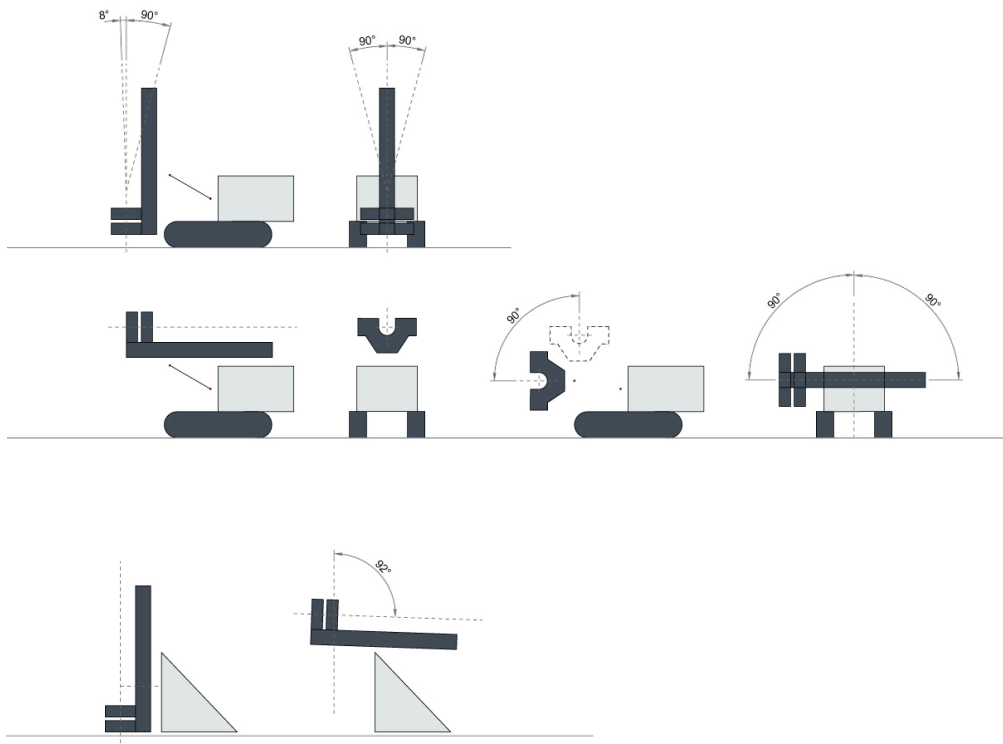

DIMENSIONI DI TRASPORTO TRANSPORT DIMENSIONS

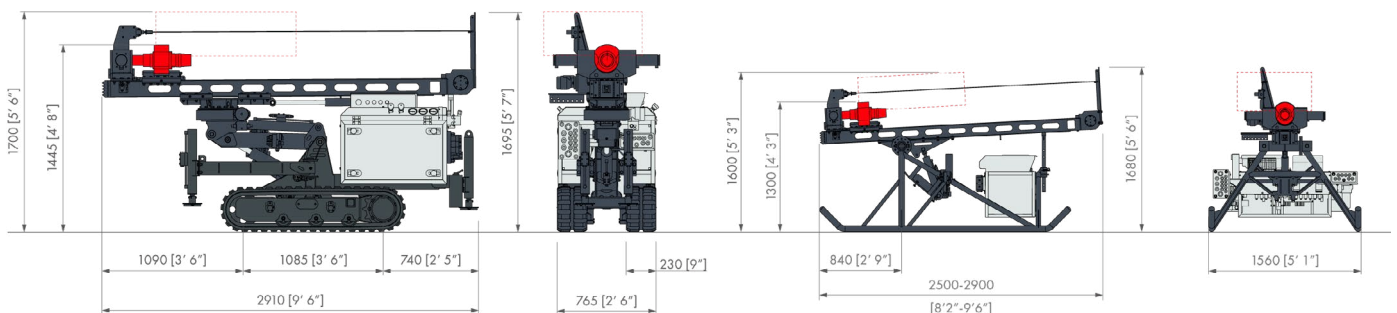

Comacchio S.p.A.
Via Callalta, 24/B
31039 Riese Pio X (TV) Italy

T +39 0423 7585
F +39 0423 755592
sales@comacchio.com

comacchio.com



UNI EN ISO 9001:2015 / ISO 14001:2015